

**Calculations executed for the 4-bladed rotor of the  
VIRYA-3.6 windmill ( $\lambda_d = 3.5$ , galvanised steel blades)**

ing. A. Kragten

March 2018

KD 652

It is allowed to copy this report for private use.

Engineering office Kragten Design  
Populierenlaan 51  
5492 SG Sint-Oedenrode  
The Netherlands  
telephone: +31 413 475770  
e-mail: [info@kdwindturbines.nl](mailto:info@kdwindturbines.nl)  
website: [www.kdwindturbines.nl](http://www.kdwindturbines.nl)

| Contains  | page |
|---|------|
| 1 Introduction  | 3    |
| 2 Description of the rotor of the VIRYA-3.6 windmill                      | 3    |
| 3 Calculations of the rotor geometry                                      | 4    |
| 4 Determination of the $C_p$ - $\lambda$ and the $C_q$ - $\lambda$ curves | 5    |
| 5 Determination of the Q-n curves   | 7    |
| 6 Calculation of the strength of the strip which connects the blades      | 9    |
| 6.1 Bending stress in the strip for a rotating rotor and $V = 8$ m/s      | 9    |
| 6.2 Bending stress in the strip for a locked rotor                        | 13   |
| 7 References  | 14   |
| Sketch VIRYA-3.6 rotor  | 15   |

## 1 Introduction

The VIRYA-3.6 windmill is designed to drive a centrifugal pump or a roll pump mounted at the tower foot using a gearing with a round string and an accelerating gear ratio  $i = 2.5$  in the windmill head and a vertical shaft in the tower centre. It might be required to use a second accelerating transmission at the tower foot. The pump is used for drainage or low head pumping for irrigation. The transmission will be described in a separate report. The VIRYA-3.6 is meant for use in western countries but also for use in developing countries. The use of stainless steel is therefore limited as much as possible. The VIRYA-3.6 windmill has a simple 4-bladed rotor with galvanised steel blades. The windmill will be provided with the hinged side vane safety system which is used in all VIRYA windmills. This safety system will be equipped with a relatively light vane blade resulting in a rated wind speed of about 8 m/s.

The 6 metre high tower has four legs made out of pipe which are connected to each other by only horizontal strips as it is also done for the VIRYA-4.2 tower. The tower has hinges at the foot. The bearings of the vertical shaft are integrated in the tower.

## 2 Description of the rotor of the VIRYA-3.6 windmill

The 4-bladed rotor of the VIRYA-3.6 windmill has a diameter  $D = 3.6$  m and a design tip speed ratio  $\lambda_d = 3.5$ . Two opposite blades are connected to each other by means of a twisted steel central strip. Advantages of this construction are that no large welded spoke assembly is required, that the rotor can be balanced easily and that the assembly of two opposite blades and a central strip can be transported completely mounted.

The rotor has blades with a constant chord and is provided with a 7.14 % cambered airfoil. A blade is made of a strip with dimensions of  $312 * 1250 * 2.5$  mm and 8 blades can be made from a standard sheet of  $1.25 * 2.5$  m. Because the blade is cambered, the chord  $c$  is a little less than the blade width, resulting in  $c = 308$  mm = 0.308 m.

Two opposite blades are connected to each other by a 1.5 m long twisted central strip size  $80 * 8$  mm. The overlap in between blade and strip is 0.2 m which results in a free blade length of 1.05 m. This blade length in combination with a design tip speed ratio of 3.5 and a blade thickness of 2.5 mm, must be enough to prevent flutter of the blade at high wind speeds. A supporting strip size  $40 * 6 * 250$  mm is welded square to each end of a central strip. The blade is connected to the central strip and the supporting strip using four M10 bolts. In between the central strip and the blade is a thin strip to prevent too strong deformation of the blade when the bolts are tightened. The bolts at the central strip are also used for connection of the balancing weights.

The hub is made of square bar  $80 * 80$  mm with a tapered hole in the centre for connection to the rotor shaft. The two central strips are clamped in between the hub and a square sheet size  $80 * 80 * 10$  mm by means of four M10 bolts and that is why the central strips are not loaded by a bending moment at the position of the holes. The rotor shaft has a diameter of 30 mm. The hub is pulled on the tapered shaft end by one central M16 bolt. The mass of a central strip and two blades is about 23.5 kg so this mass can easily be handled by one man. The mass of the whole rotor including hub is about 51 kg which seems acceptable for a complete steel rotor with a diameter of 3.6 m and a design tip speed ratio of 3.5. A sketch of the rotor is given in figure 7.

### 3 Calculation of the rotor geometry

The rotor geometry is determined using the method and the formulas as given in report KD 35 (ref. 1). This report (KD 652) has its own formula numbering. Substitution of  $\lambda_d = 3.5$  and  $R = 1.8$  m in formula (5.1) of KD 35 gives:

$$\lambda_{rd} = 1.9444 * r \quad (-) \quad (1)$$

Formula's (5.2) and (5.3) of KD 35 stay the same so:

$$\beta = \phi - \alpha \quad (^\circ) \quad (2)$$

$$\phi = 2/3 \arctan 1 / \lambda_{rd} \quad (^\circ) \quad (3)$$

Substitution of  $B = 4$  and  $c = 0.308$  m in formula (5.4) of KD 35 gives:

$$C_l = 20.40 r (1 - \cos\phi) \quad (-) \quad (4)$$

Substitution of  $V = 5$  m/s and  $c = 0.308$  m in formula (5.5) of KD 35 gives:

$$Re_r = 1.027 * 10^5 * \sqrt{(\lambda_{rd}^2 + 4/9)} \quad (-) \quad (5)$$

The blade is calculated for six stations A till F which have a distance of 0.25 m of one to another. The blade has a constant chord and the calculations therefore correspond with the example as given in chapter 5.4.2 of KD 35. This means that the blade is designed with a low lift coefficient at the tip and with a high lift coefficient at the root. First the theoretical values are determined for  $C_l$ ,  $\alpha$  and  $\beta$  and next  $\beta$  is linearised such that the twist is constant and that the linearised values for the outer part of the blade correspond as good as possible with the theoretical values. The result of the calculations is given in table 1.

The aerodynamic characteristics of a 7.14 % cambered airfoil are given in report KD 398 (ref. 2). The Reynolds values for the stations are calculated for a wind speed of 5 m/s because this is a reasonable wind speed for a windmill with  $V_{rated} = 8$  m/s. Those airfoil Reynolds numbers are used which are lying closest to the calculated values. The effect of the central strip on the aerodynamic characteristics of the inner part of the blade is neglected.

| station | r (m) | $\lambda_{rd}$ (-) | $\phi$ (°) | c (m) | $C_{lth}$ (-) | $C_{lin}$ (-) | $Re_r * 10^{-5}$<br>V = 5 m/s | $Re * 10^{-5}$<br>7.14 % | $\alpha_{th}$ (°) | $\alpha_{lin}$ (°) | $\beta_{th}$ (°) | $\beta_{lin}$ (°) | $C_d/C_{lin}$ (-) |
|---------|-------|--------------------|------------|-------|---------------|---------------|-------------------------------|--------------------------|-------------------|--------------------|------------------|-------------------|-------------------|
| A       | 1.8   | 3.5                | 10.6       | 0.308 | 0.63          | 0.70          | 3.66                          | 3.4                      | -0.7              | -0.4               | 11.3             | 11.0              | 0.042             |
| B       | 1.55  | 3.014              | 12.2       | 0.308 | 0.72          | 0.74          | 3.17                          | 3.4                      | -0.3              | -0.2               | 12.5             | 12.4              | 0.040             |
| C       | 1.3   | 2.528              | 14.4       | 0.308 | 0.83          | 0.81          | 2.69                          | 2.5                      | 0.8               | 0.6                | 13.6             | 13.8              | 0.035             |
| D       | 1.05  | 2.042              | 17.4       | 0.308 | 0.98          | 0.94          | 2.21                          | 2.5                      | 2.6               | 2.2                | 14.8             | 15.2              | 0.032             |
| E       | 0.8   | 1.556              | 21.8       | 0.308 | 1.17          | 1.15          | 1.74                          | 1.7                      | 5.4               | 5.2                | 16.4             | 16.6              | 0.048             |
| F       | 0.55  | 1.069              | 28.7       | 0.308 | 1.38          | 1.44          | 1.29                          | 1.2                      | 8.5               | 10.7               | 20.2             | 18.0              | 0.12              |

table 1 Calculation of the blade geometry of the VIRYA-3.6 rotor

The theoretical blade angle  $\beta_{th}$  for stations A to F varies in between  $11.3^\circ$  and  $20.2^\circ$ . If the blade angle is linearised in between  $11^\circ$  at the blade tip and  $18^\circ$  at the blade root, the linearised angle of attack  $\alpha_{lin}$  differs only a little from the theoretical value  $\alpha_{th}$  for the most important outer side of the blade. So the blade is twisted  $18^\circ - 11^\circ = 7^\circ$ . The central strip is twisted  $18^\circ$  right hand in between the hub and the blade root. The blade angel at the heart of a connecting strip is about  $17^\circ$  so the outer part of the central strip is twisted  $1^\circ$  back.

#### 4 Determination of the $C_p$ - $\lambda$ and the $C_q$ - $\lambda$ curves

The determination of the  $C_p$ - $\lambda$  and  $C_q$ - $\lambda$  curves is given in chapter 6 of KD 35. The average  $C_d/C_l$  ratio for the most important outer part of the blade is about 0.04. Figure 4.8 of KD 35 (for  $B = 4$ ) and  $\lambda_{opt} = 3.5$  and  $C_d/C_l = 0.04$  gives  $C_{p\ th} = 0.44$ . Substitution of  $C_{p\ th} = 0.44$ ,  $R = 1.8$  m and blade length  $k = 1.25$  m in formula 6.3 of KD 35 gives  $C_{p\ max} = 0.4$ .  $C_{q\ opt} = C_{p\ max} / \lambda_{opt} = 0.4 / 3.5 = 0.1143$ .

Substitution of  $\lambda_{opt} = \lambda_d = 3.5$  in formula 6.4 of KD 35 gives  $\lambda_{unl} = 5.6$ .

The starting torque coefficient is calculated with formula 6.12 of KD 35 which is given by:

$$C_{q\ start} = 0.75 * B * (R - \frac{1}{2}k) * C_l * c * k / \pi R^3 \quad (-) \quad (6)$$

The average blade angle is  $14.5^\circ$ . For a non rotating rotor the average angle of attack  $\alpha$  is therefore  $90^\circ - 14.5^\circ = 75.5^\circ$ . The estimated  $C_l$ - $\alpha$  curve for large values of  $\alpha$  is given as figure 5 of KD 398. For  $\alpha = 75.5^\circ$  it can be read that  $C_l = 0.48$ .

Substitution of  $B = 4$ ,  $R = 1.8$  m,  $k = 1.25$  m,  $C_l = 0.48$  and  $c = 0.308$  m in formula 6 gives that  $C_{q\ start} = 0.036$ . For the ratio in between the starting torque and the optimum torque we find that it is  $0.036 / 0.1143 = 0.315$ . This is good for a rotor with a design tip speed ratio of 3.5. The ratio is expected to be high enough for combination of the VIRYA-3.6 windmill with a centrifugal pump which has almost no starting torque. Only the friction of the transmission in between rotor and pump causes a certain starting torque  $Q_s$ .

The starting wind speed  $V_{start}$  of the rotor is calculated with formula 8.6 of KD 35 which is given by:

$$V_{start} = \sqrt{\left( \frac{Q_s}{C_{q\ start} * \frac{1}{2}\rho * \pi R^3} \right)} \quad (m/s) \quad (7)$$

At this moment the starting torque  $Q_s$  of the transmission is not yet known so the starting wind speed can't be calculated accurately. Assume  $Q_s = 4$  Nm. Substitution of  $Q_s = 4$  Nm,  $C_{q\ start} = 0.036$ ,  $\rho = 1.2$  kg/m<sup>3</sup> and  $R = 1.8$  m in formula 7 gives that  $V_{start} = 3.2$  m/s. This seems acceptable low for a 4-bladed rotor with a design tip speed ratio of 3.5.

In chapter 6.4 of KD 35 it is explained how rather accurate  $C_p$ - $\lambda$  and  $C_q$ - $\lambda$  curves can be determined if only two points of the  $C_p$ - $\lambda$  curve and one point of the  $C_q$ - $\lambda$  curve are known. The first part of the  $C_q$ - $\lambda$  curve is determined according to KD 35 by drawing a S-shaped line which is horizontal for  $\lambda = 0$ .

Kragten Design developed a method with which the value of  $C_q$  for low values of  $\lambda$  can be determined (see report KD 97 ref. 3). With this method, it can be determined that the  $C_q$ - $\lambda$  curve is directly rising for low values of  $\lambda$  if a 7.14 % cambered sheet airfoil is used. This effect has been taken into account and the estimated  $C_p$ - $\lambda$  and  $C_q$ - $\lambda$  curves for the VIRYA-3.6 rotor are given in figure 1 and 2.

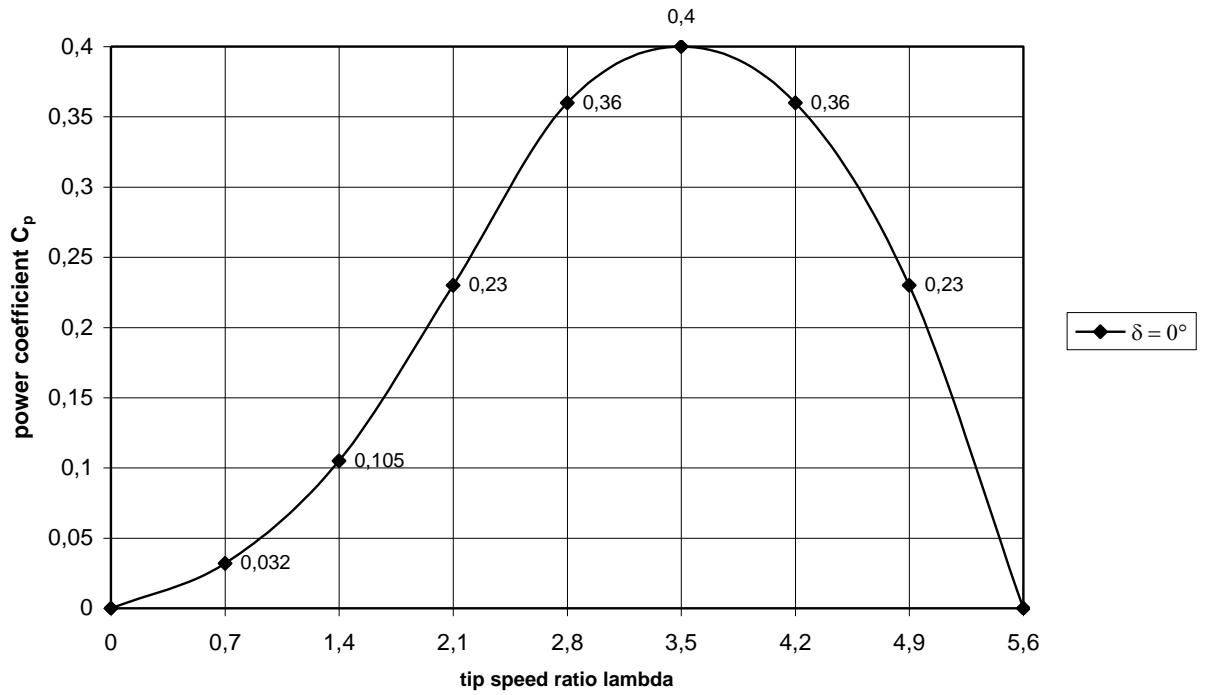

fig. 1 Estimated  $C_p$ - $\lambda$  curve for the VIRYA-3.6 rotor for the wind direction perpendicular to the rotor ( $\delta = 0^\circ$ )

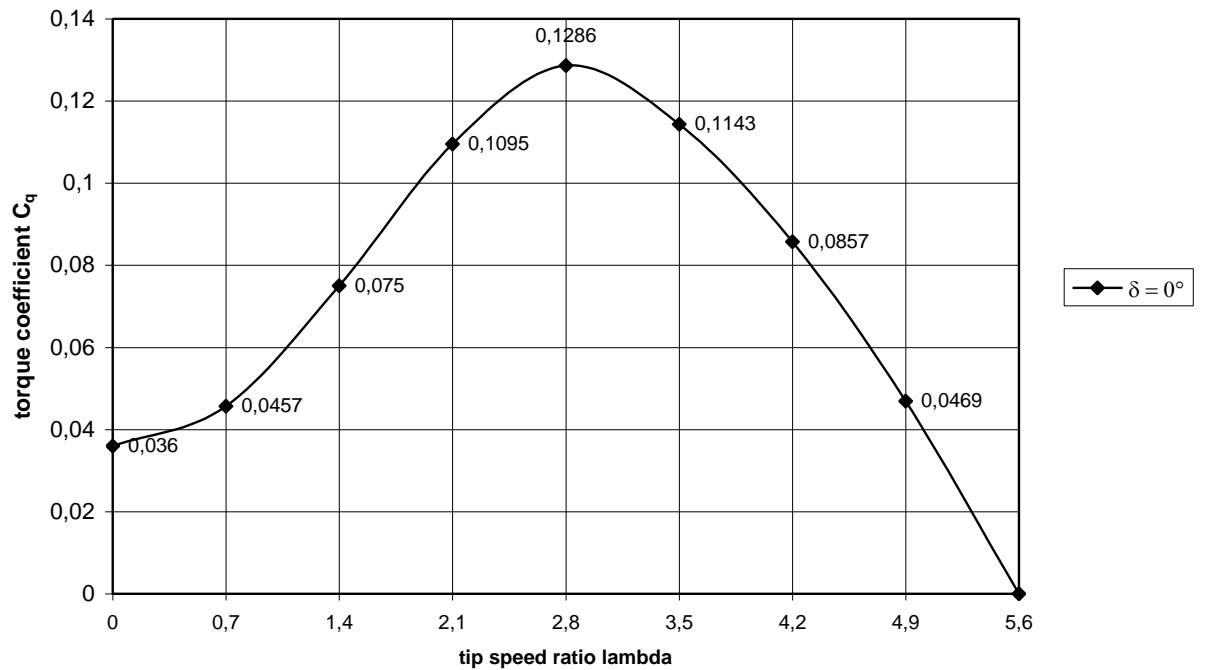

fig. 2 Estimated  $C_q$ - $\lambda$  curve for the VIRYA-3.6 rotor for the wind direction perpendicular to the rotor ( $\delta = 0^\circ$ )

## 5 Determination of the Q-n curves

The determination of the Q-n curves of a windmill rotor is described in chapter 8 of KD 35. One needs a  $C_q\text{-}\lambda$  curve of the rotor and a  $\delta\text{-V}$  curve of the safety system together with the formulas for the torque Q and the rotational speed n. The  $C_q\text{-}\lambda$  curve is given in figure 2. The  $\delta\text{-V}$  curve of the safety system depends on the safety system. As this safety system is not yet designed, the  $\delta\text{-V}$  curve of it is estimated. The estimated  $\delta\text{-V}$  curve is given in figure 3.

The head starts to turn away at a wind speed of about 5 m/s. For wind speeds above 8 m/s it is supposed that the head turns out of the wind such that the component of the wind speed perpendicular to the rotor plane, is staying constant. The Q-n curve for 8 m/s will therefore also be valid for wind speeds higher than 8 m/s.

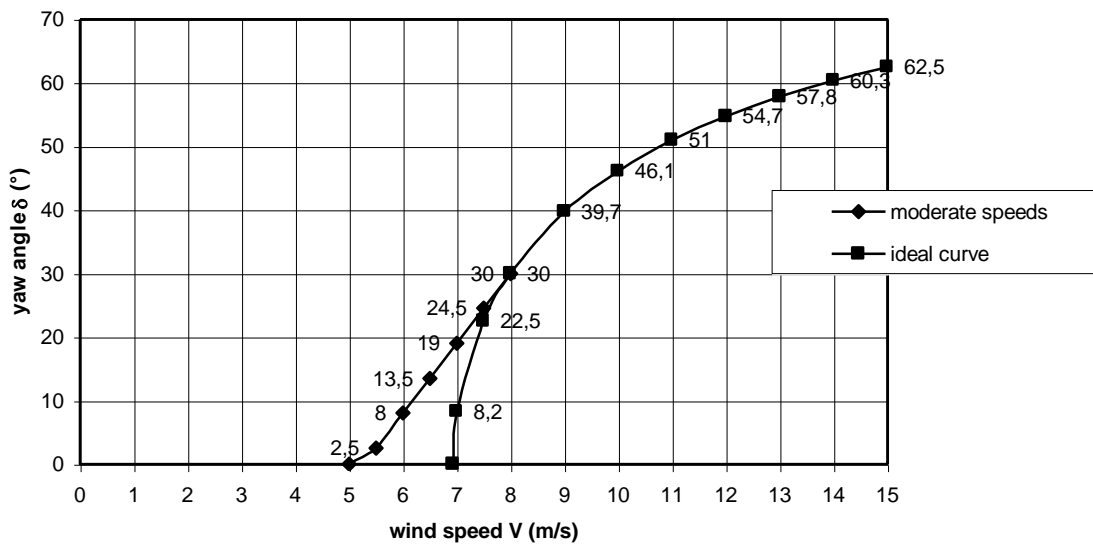

fig. 3 Estimated  $\delta\text{-V}$  curve VIRYA-3.6 safety system with  $V_{\text{rated}} = 8$  m/s

The Q-n curves are used to check the matching with the Q-n curve of the pump. The Q-n curves are determined for wind the speeds 2, 3, 4, 5, 6, 7 and 8 m/s. At high wind speeds the rotor is turned out of the wind by a yaw angle  $\delta$  and therefore the formulas for Q and n are used which are given in chapter 7 of KD 35.

Substitution of  $R = 1.8$  m in formula 7.1 of KD 35 gives:

$$n_{\delta} = 5.3052 * \lambda * \cos\delta * V \quad (\text{rpm}) \quad (8)$$

Substitution of  $\rho = 1.2$  kg / m<sup>3</sup> and  $R = 1.8$  m in formula 7.7 of KD 35 gives:

$$Q_{\delta} = 10.9931 * C_q * \cos^2\delta * V^2 \quad (\text{W}) \quad (9)$$

The Q-n curves are determined for  $C_q$  values belonging to  $\lambda$  is 0, 0.7, 1.4, 2.1, 2.8, 3.5, 4.2, 4.9 and 5.6 (see figure 2). For a certain wind speed, for instance  $V = 2$  m/s, related values of  $C_q$  and  $\lambda$  are substituted in formula 8 and 9 and this gives the Q-n curve for that wind speed. For the higher wind speeds the yaw angle as given by figure 5, is taken into account. The result of the calculations is given in table 2.

|                  |              | V = 2 m/s<br>$\delta = 0^\circ$ |           | V = 3 m/s<br>$\delta = 0^\circ$ |           | V = 4 m/s<br>$\delta = 0^\circ$ |           | V = 5 m/s<br>$\delta = 0^\circ$ |           | V = 6 m/s<br>$\delta = 8^\circ$ |                    | V = 7 m/s<br>$\delta = 19^\circ$ |                    | V = 8 m/s<br>$\delta = 30^\circ$ |                    |
|------------------|--------------|---------------------------------|-----------|---------------------------------|-----------|---------------------------------|-----------|---------------------------------|-----------|---------------------------------|--------------------|----------------------------------|--------------------|----------------------------------|--------------------|
| $\lambda$<br>(-) | $C_q$<br>(-) | n<br>(rpm)                      | Q<br>(Nm) | n<br>(rpm)                      | Q<br>(Nm) | n<br>(rpm)                      | Q<br>(Nm) | n<br>(rpm)                      | Q<br>(Nm) | $n_\delta$<br>(rpm)             | $Q_\delta$<br>(Nm) | $n_\delta$<br>(rpm)              | $Q_\delta$<br>(Nm) | $n_\delta$<br>(rpm)              | $Q_\delta$<br>(Nm) |
| 0                | 0.036        | 0                               | 1.58      | 0                               | 3.56      | 0                               | 6.33      | 0                               | 9.89      | 0                               | 13.97              | 0                                | 17.34              | 0                                | 19.00              |
| 0.7              | 0.0457       | 7.4                             | 2.01      | 11.1                            | 4.52      | 14.9                            | 8.04      | 18.6                            | 12.56     | 22.1                            | 17.74              | 24.6                             | 22.01              | 25.7                             | 24.11              |
| 1.4              | 0.075        | 14.9                            | 3.30      | 22.3                            | 7.42      | 29.7                            | 13.19     | 37.1                            | 20.61     | 44.1                            | 29.11              | 49.2                             | 36.12              | 51.5                             | 39.58              |
| 2.1              | 0.1095       | 22.3                            | 4.81      | 33.4                            | 10.83     | 44.6                            | 19.26     | 55.7                            | 30.09     | 66.2                            | 42.50              | 73.7                             | 52.73              | 77.2                             | 57.78              |
| 2.8              | 0.1286       | 29.7                            | 5.65      | 44.6                            | 12.72     | 59.4                            | 22.62     | 74.3                            | 35.34     | 88.3                            | 49.91              | 98.3                             | 61.93              | 102.9                            | 67.86              |
| 3.5              | 0.1143       | 37.1                            | 5.03      | 55.7                            | 11.31     | 74.3                            | 20.10     | 92.8                            | 31.41     | 110.3                           | 44.36              | 122.9                            | 55.04              | 128.6                            | 60.31              |
| 4.2              | 0.0857       | 44.6                            | 3.77      | 66.8                            | 8.48      | 89.1                            | 15.07     | 111.4                           | 23.55     | 132.4                           | 33.26              | 147.5                            | 41.27              | 154.4                            | 45.22              |
| 4.9              | 0.0469       | 52.0                            | 2.06      | 78.0                            | 4.64      | 104.0                           | 8.25      | 130.0                           | 12.89     | 154.5                           | 18.20              | 172.1                            | 22.59              | 180.1                            | 24.75              |
| 5.6              | 0            | 59.4                            | 0         | 89.1                            | 0         | 118.8                           | 0         | 148.5                           | 0         | 176.5                           | 0                  | 196.6                            | 0                  | 205.8                            | 0                  |

table 2 Calculated values of n and Q as a function of  $\lambda$  and V for the VIRYA-3.6 rotor

The calculated values for n and Q are plotted in figure 4.

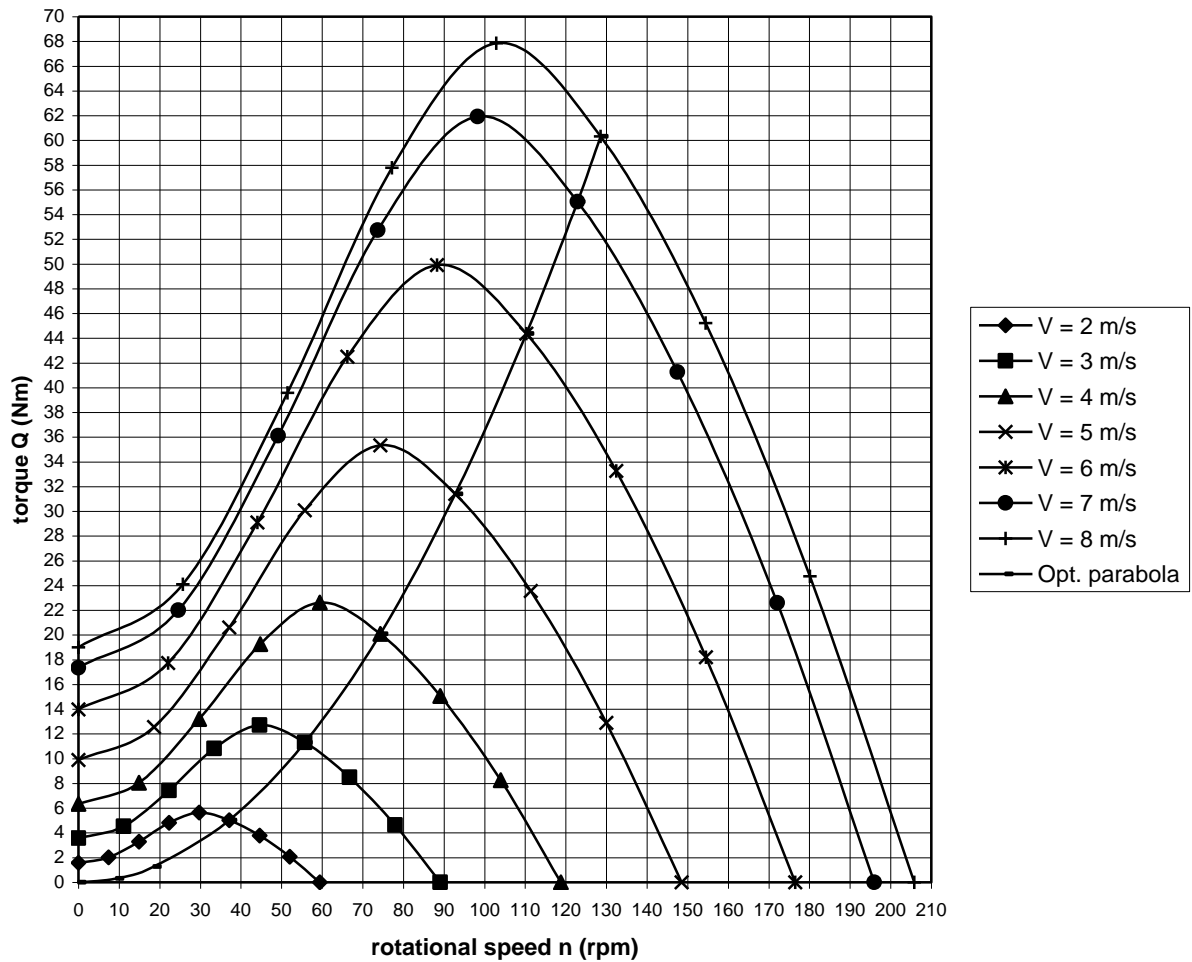

fig. 4 Q-n curves of the VIRYA-3.6 rotor

The optimum parabola which is going through the points with  $\lambda = 3.5$ , where  $C_p$  is maximum, is also drawn in figure 4.



## 6 Calculation of the strength of the strip which connects the blades

Two opposite blades are connected to each other by a strip with a length of 1500 mm, a width  $b = 80$  mm and a height  $h = 8$  mm. The strip is loaded by a bending moment with axial direction which is caused by the rotor thrust and by the gyroscopic moment. The strip is also loaded by a centrifugal force and by a bending moment with tangential direction caused by the torque and by the weight of the blade but the stresses which are caused by these loads can be neglected.

Because the strip is thin and long it makes the blade connection elastic and therefore the blade will bend backwards already at a low load. As a result of this bending, a moment with direction forwards is created by a component of the centrifugal force in the blade. The bending is substantially decreased by this moment and this has a favourable influence on the bending stress.

It is started with the determination of the bending stress which is caused by the rotor thrust. There are two critical situations:

1° The load which appears for a rotating rotor at  $V_{\text{rated}} = 8$  m/s. For this situation the bending stress is decreased by the centrifugal moment. The yaw angle is  $30^\circ$  for  $V_{\text{rated}} = 8$  m/s.

2° The load which appears for a locked rotor. The rotor is locked by connecting a blade strip to the head (never connect a blade strip to the tower) or by locking the vertical shaft in the tower centre. An alternative might be to close the pressure pipe of the pump. A centrifugal pump will then rotate only slowly.

### 6.1 Bending stress in the strip for a rotating rotor and $V = 8$ m/s

The rotor thrust is given by formula 7.4 of KD 35. The rotor thrust is the axial load of all blades together and exerts in the hart of the rotor. The thrust per blade  $F_{t \delta \text{ bl}}$  is the rotor thrust  $F_{t \delta}$  divided by the number of blades  $B$ . This gives:

$$F_{t \delta \text{ bl}} = C_t * \cos^2 \delta * \frac{1}{2} \rho V^2 * \pi R^2 / B \quad (\text{N}) \quad (10)$$

For the rotor theory it is assumed that every small area  $dA$  which is swept by the rotor, supplies the same amount of energy and that the generated energy is maximised. For this situation the wind speed in the rotor plane has to be slowed down till  $2/3$  of the undisturbed wind speed  $V$ . This results in a pressure drop over the rotor plane which is the same for every value of  $r$ . It can be proven that this results in a triangular axial load which forms the thrust and in a constant radial load which supplies the torque. The theoretical thrust coefficient  $C_t$  for the whole rotor is  $8/9 = 0.889$  for the optimal tip speed ratio. In practice  $C_t$  is lower because of the tip losses and because the blade is not effective up to the rotor centre. The blade length  $k$  of the VIRYA-3.6 rotor is 1.25 m but the rotor radius  $R = 1.8$  m. Therefore there is a disk in the centre with an area of about 0.093 of the rotor area on which no thrust is working. This results in a theoretical thrust coefficient  $C_t = 8/9 * 0.907 = 0.806$ . Because of the tip losses the real  $C_t$  value is substantially lower. Assume this results in a real practical value of  $C_t = 0.75$ .

Substitution of  $C_t = 0.75$ ,  $\delta = 30^\circ$ ,  $\rho = 1.2$  kg/m<sup>3</sup>,  $V = 8$  m/s,  $R = 1.8$  m and  $B = 4$  in formula 10 gives  $F_{t \delta \text{ bl}} = 55$  N.

For a pure triangular load, the same moment is exerted in the hart of the rotor as for a point load which exerts in the centre of gravity of the triangle. The centre of gravity is lying at  $2/3 R = 1.2$  m. Because the blade length is only  $k$ , there is no triangular load working on the blade but a load with the shape of a trapezium as the triangular load over the part  $R - k$  falls off. The centre of gravity of the trapezium has been determined graphically and is lying at about  $r_1 = 1.25$  m.

The maximum bending stress is not caused at the hart of the rotor but at the edge of the hub because the strip bends backwards from this edge. This edge is lying at  $r_2 = 0.04$  m. At this edge we find a bending moment  $M_{b_t}$  caused by the thrust which is given by:

$$M_{b_t} = F_{t \delta_{bl}} * (r_1 - r_2) \quad (\text{Nm}) \quad (11)$$

Substitution of  $F_{t \delta_{bl}} = 55$  N,  $r_1 = 1.25$  m and  $r_2 = 0.04$  m gives  $M_{b_t} = 66.6$  Nm = 66600 Nmm.

For the stress we use the unit  $\text{N/mm}^2$  so the bending moment has to be given in Nmm. The bending stress  $\sigma_b$  is given by:

$$\sigma_b = M / W \quad (\text{N/mm}^2) \quad (12)$$

The moment of resistance  $W$  of a strip is given by:

$$W = 1/6 bh^2 \quad (\text{mm}^3) \quad (13)$$

(12) + (13) gives:

$$\sigma_b = 6 M / bh^2 \quad (\text{N/mm}^2) \quad (\text{M in Nmm}) \quad (14)$$

Substitution of  $M = 66600$  Nmm,  $b = 80$  mm and  $h = 8$  mm in formula 14 gives  $\sigma_b = 78$   $\text{N/mm}^2$ . For this stress the effect of the stress reduction by bending forwards of the blade caused by the centrifugal force in the blade has not yet been taken into account. The gyroscopic moment has also not yet been taken into account.

Next it is investigated how far the blade bends backwards as a result of the thrust load and what influence this bending has on the centrifugal moment. Hereby it is assumed that the strip is bending only in between the hub and the inner connection bolt of blade and central strip. So it is assumed that the blade itself is not bending. The inner connection bolt is lying at  $r_3 = 0.575$  m = 575 mm. So the length of the strip  $l$  which is loaded by bending is given by:

$$l = r_3 - r_2 \quad (\text{mm}) \quad (15)$$

The load from the blade on the strip at  $r_3$  can be replaced by a moment  $M$  and a point load  $F$ .  $F$  is equal to  $F_{t \delta_{bl}}$ .  $M$  is given by:

$$M = F * (r_1 - r_3) \quad (\text{Nmm}) \quad (16)$$

The bending angle  $\phi$  (in radians) at  $r_3$  for a strip with a length  $l$  is given by (combination of the standard formulas for a moment plus a point load):

$$\phi = l * (M + 1/2 Fl) / EI \quad (\text{rad}) \quad (17)$$

The bending moment of inertia  $I$  of a strip is given by:

$$I = 1/12 bh^3 \quad (\text{mm}^4) \quad (18)$$

(15) + (16) + (17) + (18) gives:

$$\phi = 12 * F * (r_3 - r_2) * \{(r_1 - r_3) + 1/2 (r_3 - r_2)\} / (E * bh^3) \quad (\text{rad}) \quad (19)$$

Substitution of  $F = 55 \text{ N}$ ,  $r_3 = 575 \text{ mm}$ ,  $r_2 = 40 \text{ mm}$ ,  $r_1 = 1250 \text{ mm}$ ,  $E = 2.1 * 10^5 \text{ N/mm}^2$ ,  $b = 80 \text{ mm}$  and  $h = 8 \text{ mm}$  in formula 19 gives:  $\phi = 0.03869 \text{ rad} = 2.22^\circ$ . This is an angle which can not be neglected. In report R409D (ref. 4) a formula is derived for the angle  $\varepsilon$  with which the blade moves backwards if it is connected to the hub by a hinge. This formula is valid if both the axial load and the centrifugal load are triangular. For the VIRYA-3.6 this is not exactly the case but the formula gives a good approximation. The formula is given by:

$$\varepsilon = \arcsin\left(\frac{C_t * \rho * R^2 * \pi}{B * A_{pr} * \rho_{pr} * \lambda^2}\right) \quad (^\circ) \quad (20)$$

In this formula  $A_{pr}$  is the cross sectional area of the airfoil (in  $\text{m}^2$ ) and  $\rho_{pr}$  is the density of the used airfoil material (in  $\text{kg/m}^3$ ). For a plate width of 312 mm and a plate thickness of 2.5 mm it is found that  $A_{pr} = 0.00078 \text{ m}^2$ . The blade is made of steel sheet with a density  $\rho_{pr}$  of about  $\rho_{pr} = 7.8 * 10^3 \text{ kg/m}^3$ . The centrifugal pump must be chosen such that the matching is perfect at a rather low wind speed of about 4 m/s. So for this wind speed the rotor runs at the design tip speed ratio  $\lambda_d = 3.5$ . However, for higher wind speeds the pump load will be too low to follow the optimum parabola of the rotor. It is assumed that the rotor runs at a tip speed ratio  $\lambda = 4.2$  for a wind speed of 8 m/s. Substitution of  $C_t = 0.75$ ,  $\rho = 1.2 \text{ kg/m}^3$ ,  $R = 1.8 \text{ m}$ ,  $B = 4$ ,  $A_{pr} = 0.00078 \text{ m}^2$ ,  $\rho_{pr} = 7.8 * 10^3 \text{ kg/m}^3$  and  $\lambda = 4.2$  in formula 20 gives:  $\varepsilon = 1.22^\circ$ . This angle is smaller than the calculated angle of  $2.22^\circ$  with which the blade would bend backwards if the compensating effect of the centrifugal moment is not taken into account. This means that the real bending angle will be less than  $1.22^\circ$ .

The real bending angle  $\varepsilon$  is determined as follows. A thrust moment  $M_t = 66.6 \text{ Nm}$  is working backwards and  $M_t$  is independent of  $\varepsilon$  for small values of  $\varepsilon$ . A bending moment  $M_b$  is working forwards and  $M_b$  is proportional with  $\varepsilon$ .  $M_b = 66.6 \text{ Nm}$  for  $\varepsilon = 2.22^\circ$ . A centrifugal moment  $M_c$  is working forwards and  $M_c$  is also proportional with  $\varepsilon$ .  $M_c = 66.6 \text{ Nm}$  for  $\varepsilon = 1.22^\circ$ . The path of these three moments is given in figure 5. The sum total of  $M_b + M_c$  is determined and the line  $M_b + M_c$  is also given in figure 5.

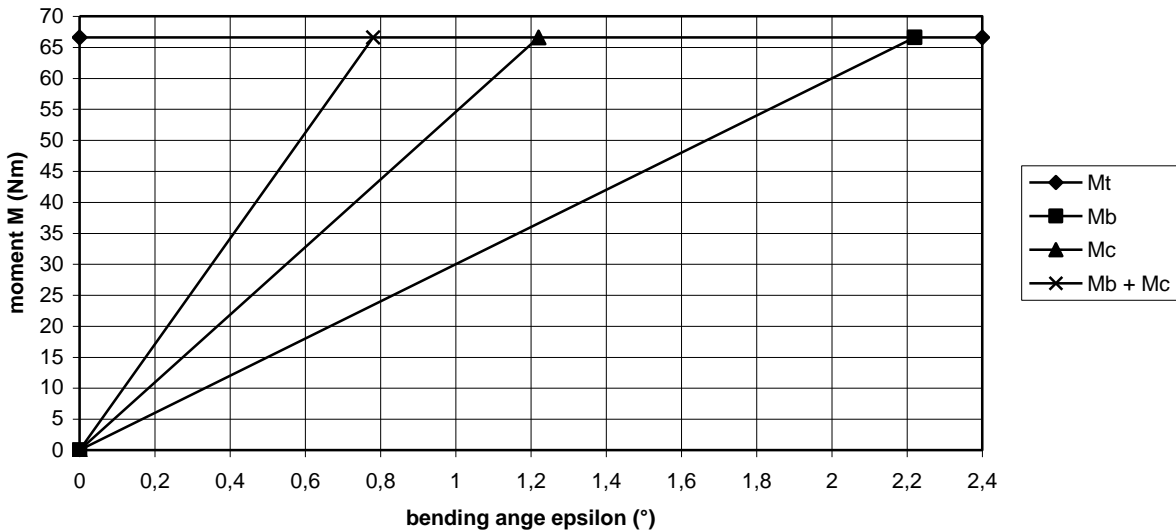

fig. 5 Path of  $M_t$ ,  $M_b$ ,  $M_c$ , and  $M_b + M_c$  as a function of  $\varepsilon$

The point of intersection of the line of  $M_t$  with the line of  $M_b + M_c$  gives the final angle  $\varepsilon$ . In figure 5 it can be seen that  $\varepsilon = 0.79^\circ$ . This is a factor 0.356 of the calculated angle of  $2.22^\circ$ . Because the bending stress is proportional to the bending angle it will also be a factor 0.356 of the calculated stress of  $78 \text{ N/mm}^2$  resulting in a stress of about  $28 \text{ N/mm}^2$ .

This is a low stress but up to now the gyroscopic moment, which can be rather large, has not yet been taken into account. The gyroscopic moment is caused by simultaneously rotation of rotor and head. One can distinguish the gyroscopic moment in a blade and the gyroscopic moment which is exerted by the whole rotor on the rotor shaft and so on the head. On a rotating mass element  $dm$  at a radius  $r$ , a gyroscopic force  $dF$  is working which is maximum if the blade is vertical and zero if the blade is horizontal and which varies with  $\sin\alpha$  with respect to a rotating axis frame.  $\alpha$  is the angle with the blade axis and the horizon. So it is valid that  $dF = dF_{\max} * \sin\alpha$ . The direction of  $dF$  depends on the direction of rotation of both axis and  $dF$  is working forwards or backwards. The moment  $dF * r$  which is exerted by this force with respect to the blade is therefore varying sinusoidal too.

However, if the moment is determined with respect to a fixed axis frame it can be proven that it varies with  $dF_{\max} * r \sin^2\alpha$  with respect to the horizontal x-axis and with  $dF_{\max} * \sin\alpha * \cos\alpha$  with respect to the vertical y-axis. For two and more bladed rotors it can be proven that the resulting moment of all mass elements around the y-axis is zero.

For a single blade and for two bladed rotors, the resulting moment of all mass elements with respect to the x-axis is varying with  $\sin^2\alpha$ , so just the same as for a single mass element. However, for three and more bladed rotors, the resulting moment of all mass elements with respect to the x-axis is constant. The resulting moment with respect to the x-axis for a three (or more) bladed rotor is given by the formula:

$$M_{\text{gyr x-as}} = I_{\text{rot}} * \Omega_{\text{rot}} * \Omega_{\text{head}} \quad (\text{Nm}) \quad (21)$$

In this formula  $I_{\text{rot}}$  is the mass moment of inertia of the whole rotor,  $\Omega_{\text{rot}}$  is the angular velocity of the rotor and  $\Omega_{\text{head}}$  is the angular velocity of the head. The resulting moment is constant for a four bladed rotor because adding four  $\sin^2\alpha$  functions which make an angle of  $90^\circ$  which each other, appear to result in a constant value. The four functions are given in figure 6. It can be proven that the sum moment for all four blades is two times the peak value of one blade.

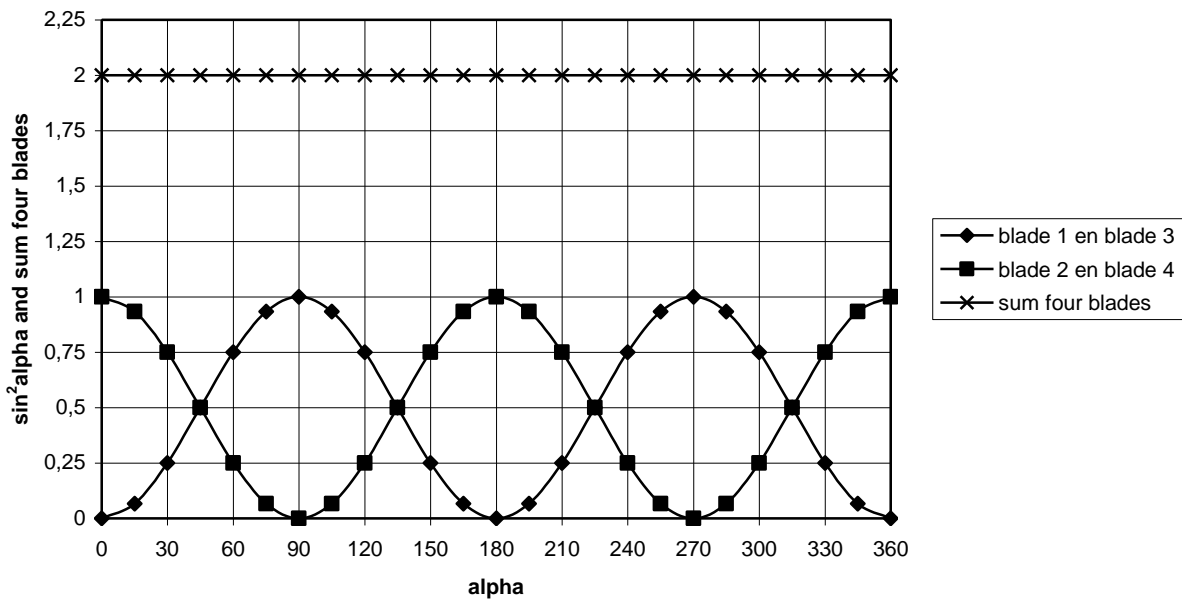

fig. 6 Variation of  $\sin^2\alpha$  and the sum of four moments

We are not interested in the variation of the gyroscopic moment in a blade with respect to the x-axis but in the variation of the moment with respect to an axis frame with rotates with the blade. If the blade is vertical both axis coincide and the moment is the same for both axis frames. The peak moment in one blade is therefore half the value of the moment given by formula 21, so:

$$M_{\text{gyr bl max}} = 0.5 * I_{\text{rot}} * \Omega_{\text{rot}} * \Omega_{\text{head}} \quad (\text{Nm}) \quad (22)$$

For a four bladed rotor, the moment of inertia of the whole rotor  $I_{\text{rot}}$  is four times the moment of inertia of one blade  $I_{\text{bl}}$ . Therefore it is valid that:

$$M_{\text{gyr bl max}} = 2 I_{\text{bl}} * \Omega_{\text{rot}} * \Omega_{\text{head}} \quad (\text{Nm}) \quad (23)$$

Up to now it is assumed that the blades have an infinitive stiffness. However, in reality the blades are flexible and will bend by the fluctuations of the gyroscopic moment. Therefore the blade will not follow the curve for which formula 21 and 23 are valid. I am not able to describe this effect physically but the practical result of it is that the strong fluctuation on the  $\sin^2\alpha$  function is rather flattened. However, the average moment is assumed to stay the same as given by formula 21. I estimate that the flattened peak value of  $M_{\text{gyr bl max}}$  is given by:

$$M_{\text{gyr bl max flattened}} = 1.2 I_{\text{bl}} * \Omega_{\text{rot}} * \Omega_{\text{head}} \quad (\text{Nm}) \quad (24)$$

For the chosen blade geometry it is calculated that  $I_{\text{bl}} = 12.4 \text{ kgm}^2$ . The maximum loaded rotational speed of the rotor can be read in figure 4 and table 2 for  $\lambda = 4.2$  and it is found that  $n_{\text{max}} = 154.4 \text{ rpm}$ . This gives  $\Omega_{\text{rot max}} = 16.2 \text{ rad/s}$  (because  $\Omega = \pi * n / 30$ ).

It is not easy to determine the maximum yawing speed. The VIRYA-2.B2 will be with a safety system which has a large moment of inertia of the head around the tower axis and therefore sudden variations in wind speed and wind direction will be followed only slowly. It is assumed that the maximum angular velocity of the head can be  $0.2 \text{ rad/s}$  at very high wind speeds.

Substitution of  $I_{\text{bl}} = 12.4 \text{ kgm}^2$ ,  $\Omega_{\text{rot max}} = 16.2 \text{ rad/s}$  and  $\Omega_{\text{head max}} = 0.2 \text{ rad/s}$  in formula 24 gives:  $M_{\text{gyr bl max}} = 48.2 \text{ Nm} = 48200 \text{ Nmm}$ .

Substitution of  $M = 48200 \text{ Nmm}$ ,  $b = 80 \text{ mm}$  and  $h = 8 \text{ mm}$  in formula 14 gives  $\sigma_{\text{b max}} = 56 \text{ N/mm}^2$ . This value has to be added to the bending stress of  $34 \text{ N/mm}^2$  which was the result of the thrust because there is always a position were both moments are strengthening each other. This gives  $\sigma_{\text{b tot max}} = 90 \text{ N/mm}^2$ . The minimum stress is  $34 - 56 = -22 \text{ N/mm}^2$ . So the stress is becoming negative and therefore it is necessary to take the load as a fatigue load.

For the strip material hot rolled strip Fe360 is chosen. For hot rolled strip the allowable stress for a load in between zero and maximum is about  $190 \text{ N/mm}^2$  and for a fatigue load it is about  $140 \text{ N/mm}^2$ . The calculated stress is lower than the allowable fatigue stress so the strip is strong enough.

In reality the blade is not extremely stiff and will also bend somewhat. This reduces the bending of the strip and therefore the stress in the strip will be somewhat lower.

## 6.2 Bending stress in the strip for a locked rotor

The rotational speed for a rotor which is stopped by locking of the rotor is zero. Therefore there is no compensating effect of the centrifugal moment on the moment of the thrust. However, there is also no gyroscopic moment. The safety system is also working if the rotor is slowed down but a much larger wind speed will be required to generate the same thrust as for a rotating rotor.

In chapter 6.1 it has been calculated that the maximum thrust on one blade for a rotating rotor is 33.3 N for  $V = V_{\text{rated}} = 8 \text{ m/s}$  and  $\delta = 30^\circ$ . The head turns out of the wind such at higher wind speeds, that the thrust stays almost constant above  $V_{\text{rated}}$ . A slowed down rotor will therefore also turn out of the wind by  $30^\circ$  if the force on one blade is 55 N. Also for a slowed down rotor the force is staying constant for higher yaw angles. However, for a slowed down rotor, the resulting force of the blade load is exerting in the middle of the blade at  $r_4 = 1.175 \text{ m}$  because the relative wind speed is constant along the whole blade. The bending moment around the edge of the hub is therefore somewhat smaller. Formula 11 changes into:

$$M_{b\ t} = F_{t\ \delta\ bl} * (r_4 - r_2) \quad (\text{Nm}) \quad (25)$$

Substitution of  $F_{t\ \delta\ bl} = 55 \text{ N}$ ,  $r_4 = 1.175 \text{ m}$  and  $r_2 = 0.04 \text{ m}$  in formula 25 gives  $M_{b\ t} = 62.4 \text{ Nm} = 62400 \text{ Nmm}$ . Substitution of  $M = 62400 \text{ Nmm}$ ,  $b = 80 \text{ mm}$  and  $h = 8 \text{ mm}$  in formula 14 gives  $\sigma_b = 73 \text{ N/mm}^2$ . This is lower than the calculated stress for a rotating rotor. The load is not fluctuating and therefore it is surely not necessary to use the allowable fatigue stress. The allowable stress is  $190 \text{ N/mm}^2$  for hot rolled strip, so the strip is strong enough.

## 7 References

- 1 Kragten A. Rotor design and matching for horizontal axis wind turbines, January 1999, reviewed November 2015, free public report KD 35, engineering office Kragten Design, Populierenlaan 51, 5492 SG Sint-Oedenrode, The Netherlands.
- 2 Kragten A. The 7.14 %, 10 % and 12.5 % cambered plate as airfoil for windmill rotor blades, Aerodynamic characteristics, geometry, moment of inertia I and moment of resistance W, November 2002, free public report KD 96, engineering office Kragten Design, Populierenlaan 51, 5492 SG Sint-Oedenrode, The Netherlands.
- 3 Kragten A. Determination of  $C_q$  for low values of  $\lambda$ . Deriving the  $C_p$ - $\lambda$  and  $C_q$ - $\lambda$  curves of the VIRYA-1.8D rotor, July 2002, free public rapport KD 97, engineering office Kragten Design, Populierenlaan 51, 5492 SG Sint-Oedenrode, The Netherlands).
- 4 Kragten A. Bepaling kegelhoek  $\varepsilon$  en de grootte van de centrifugaalgewichten voor snellopende propellers, in Dutch, July 1980, report R 409 D, University of Technology Eindhoven, Faculty of Physics, Laboratory of Fluid Dynamics and Heat Transfer, P.O. box 513, 5600 MB Eindhoven, The Netherlands, (report probably no longer available).

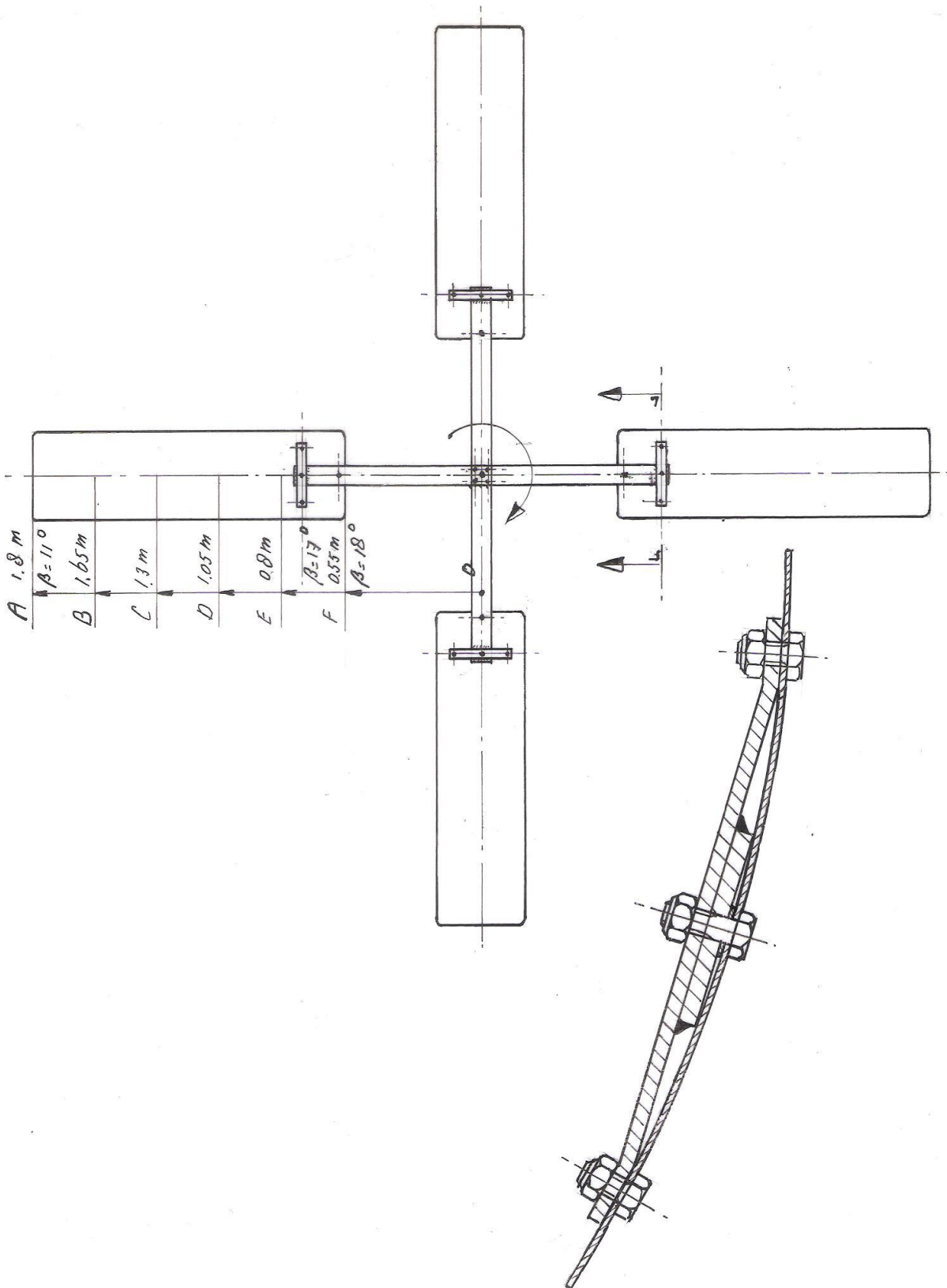

fig. 7 Sketch VIRYA-3.6 rotor

The blade is twisted  $7^\circ$  in between station A and F. It might be possible to use a standard roll bender and to feed the blade into the roll bender with a certain angle in between the long side of the blade and the roll axis and then automatically realise the correct twist. One should try this to find the correct angle. Another advantage of this method is that one will have almost no straight parts at the beginning and the end of the camber.